



KERN & Sohn GmbH

Ziegelei 1

D-72336 Balingen

E-Mail: info@kern-sohn.com

Phone: +49-[0]7433- 9933-0

Fax: +49-[0]7433-9933-149

Internet: www.kern-sohn.com

Operating manual

Electronic Moisture Analyser

KERN DAB

Version 1.1

10/2015

GB



DAB-BA-e-1511



KERN DAB

Version 1.1 10/2015

Operating manual

Electronic Moisture Analyser

Contents



1	TECHNICAL DATA.....	5
2	APPLIANCE OVERVIEW	7
2.1	Keyboard overview	9
2.2	Overview of display	10
3	BASIC INFORMATION (GENERAL)	11
3.1	Proper use	11
3.2	Improper Use.....	11
3.3	Warranty	11
3.4	Monitoring of Test Resources	11
4	BASIC SAFETY PRECAUTIONS	12
4.1	Pay attention to the instructions in the Operation Manual	12
4.2	Symbols used in the operating instructions.....	12
4.2.1	Warning pictograms	13
4.3	Personnel training	13
4.4	Danger Information.....	14
5	TRANSPORT AND STORAGE.....	16
5.1	Testing upon acceptance.....	16
5.2	Packaging / return transport.....	16

English

6	UNPACKING, SETUP AND COMMISSIONING	16
6.1	Installation Site, Location of Use	16
6.2	Unpacking and checking	17
6.2.1	Scope of delivery / serial accessories:.....	17
6.3	Placing	18
6.4	Levelling	19
6.5	Mains connection.....	20
6.6	Switching on and off.....	20
6.6.1	Initial Commissioning	21
6.7	Connection of peripheral devices	21
7	ADJUSTMENT	22
7.1	Weight adjustment.....	22
7.2	Calibrate / adjust temperature of the heating module	24
7.2.1	Temperature calibration	24
7.2.2	Temperature adjustment.....	27
8	CARRY OUT YOUR FIRST MEASUREMENT	28
9	DEFINE DRYING PARAMETERS	30
1.	Enter ident number for drying method.....	30
2.	Set heating profile.....	31
3.	Selecting switch-off criterion	33
4.	Set drying temperature	34
5.	Setting the drying period for time-controlled switching-off.....	35
10	CARRYING OUT DRYING AND MEASURING PROCESSES	36
11	RS 232 INTERFACE	39
11.1	Technical data.....	39
11.2	Setting the baud rate.....	39
11.3	Print out protocol:	40

12	GENERAL INFORMATION CONCERNING MOISTURE ANALYSIS.....	42
12.1	Application	42
12.2	Basics	42
12.3	Adjustment to existing measuring method	42
12.4	Preparing a sample	43
12.5	Sample material	44
12.6	Sample size / originally weighted in quantity	44
12.7	Drying temperature	45
12.8	Recommendations / Guidelines	45
13	SERVICING, MAINTENANCE, DISPOSAL	46
13.1	Cleaning	46
13.2	Servicing, maintenance	46
13.3	Disposal.....	46
14	INSTANT HELP	47
15	DECLARATION OF CONFORMITY	48

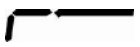
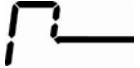
1 Technical data

Data	DAB 100-3	
Radiator type	Halogen (1 x 400 W)	
Temperature range	40°C - 199°C 1°C steps selectable	
Maximum load (Max)	110 g	
Minimum weight (min)	0.02 g	
Readability (d)	0.001g / 0.01 %	
Reproducibility	Weighed-in quantity 2 g: 0.15 %	
	Weighed-in quantity 5g: 0.05 %	
	Weighed-in quantity 10 g: 0.02 %	
Heating profiles		Standard drying
		Fast drying
		Soft drying
Linearity	± 0.003 g	
Stabilization time (typical)	3 sec.	
Warm-up time	2 h	
Recommended adjustment weight, not added (class)	100g (F2)	
Environmental conditions	5°C....+40°C ambient temperature max 80% air humidity non-condensing	

Shutoff criterion	<ul style="list-style-type: none"> • Automatic switch off (2mg weight loss in 45 s) • Time-controlled switch off, selectable 3 min – 99h 59 min (10s steps) • Manual switch-off by pressing stop key 	
Sample dishes included	Ø 95 mm	
Displays of result	[%] moisture content [%] dry content [g] residual weight in grams	
Internal memory	Method memory	15 memory locations for drying methods
	Sample memory	5 memory locations for measurement results
Interface	RS232	
Dimensions (W x D x H)	Housing 240 x 365 x 180 mm	
Available drying room	Ø 92 mm, 20 mm high	
Net weight	4.8 kg	
Electric Supply	220V 50 Hz AC	

2 Appliance overview

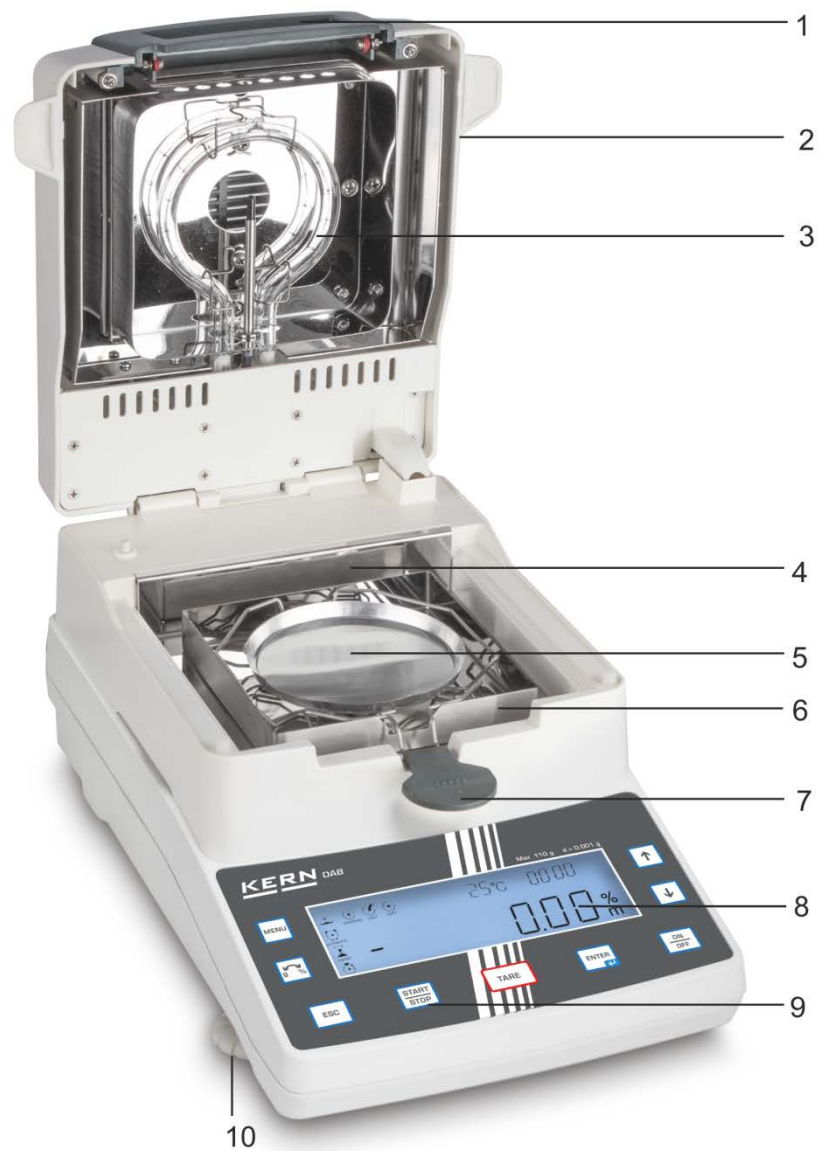









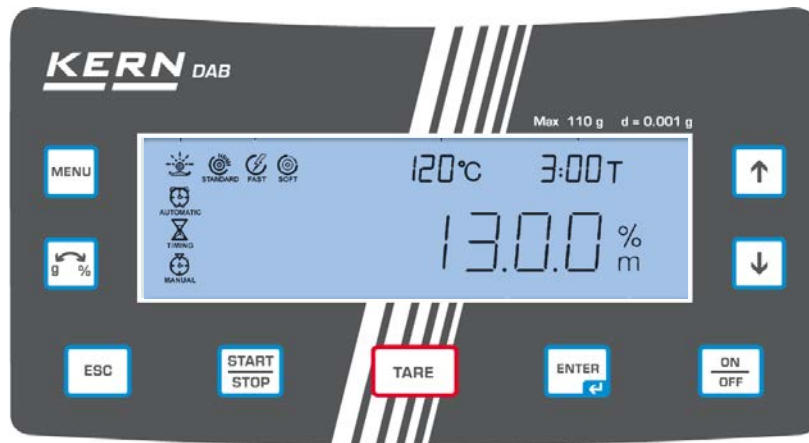

Pos.	Designation
1	Viewing panel
2	Heating hood
3	Halogen lamp
4	Heat shield
5	Sample dish
6	Windshield
7	Removal aid
8	Display
9	Keyboard
10	Adjustable foot



Pos.	Designation
11	RS232C-interface connection
12	Bubble level
13	Fan
14	Mains connection socket

2.1 Keyboard overview







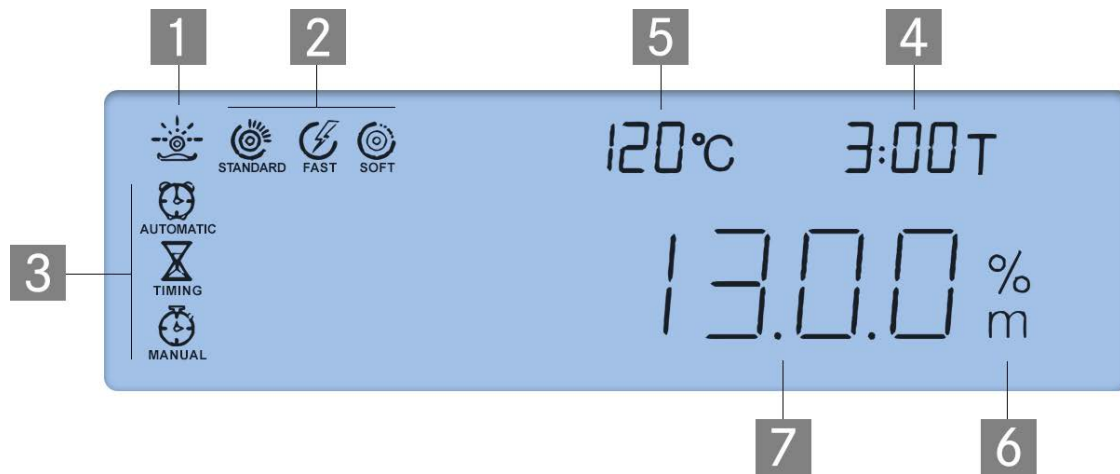

Button	Function
	<ul style="list-style-type: none"> • Call up menu
	<ul style="list-style-type: none"> • Switch over display of result
	<ul style="list-style-type: none"> • Cancel
	<ul style="list-style-type: none"> • Start / finish drying and measuring process
	<ul style="list-style-type: none"> • Taring
	<ul style="list-style-type: none"> • Confirm / store settings
	<ul style="list-style-type: none"> • Turn on/off
	<ul style="list-style-type: none"> • Select parameter (forward) • Increase digit • Switch on background illumination of display
	<ul style="list-style-type: none"> • Select parameter (backward) • Reduce digit • Switch off background illumination of display

2.2 Overview of display

Example: Working window during drying process



Pos.	Designation
1	 Status display - drying process enabled
2	Enabled heating profile flashes  Standard drying  Fast drying  Soft drying
3	Enabled switch-off criterion flashes  Automatic switch-off  Time controlled switch-off  Manual switch off
4	Previous drying time
5	Current temperature
6	Display in % moisture
7	Subtotal

3 Basic Information (General)

3.1 Proper use

The device purchased by you is designed for a fast and reliable determination of material moisture in liquid, porous and solid materials by applying the method of thermogravimetrics.

3.2 Improper Use

Impacts and overloading exceeding the stated maximum load (max) of the device, minus a possibly existing tare load, must be strictly avoided.

This could cause damage to the integrated balance.

Never operate device in explosive environment. The serial version is not explosion protected.

Changes to the unit's design are not permitted. This may lead to incorrect weighing results, safety-related faults and destruction of the appliance.

The unit may only be operated in accordance with the described default settings. Other areas of use must be released by KERN in writing.

3.3 Warranty

Loss of warranty due to

- Our conditions in the operation manual are ignored
- The appliance is used outside the described uses
- Changing or opening instrument
- Mechanical damage and damage caused by media, liquids
- Natural wear and tear
- The appliance is improperly set up or incorrectly electrically connected
- The measuring system is overloaded

3.4 Monitoring of Test Resources

In the framework of quality assurance the measuring-related properties of the integrated balance and, if applicable, the testing weight, must be checked regularly. The responsible user must define a suitable interval as well as type and scope of this test. Information is available on KERN's home page (www.kern-sohn.com) with regard to the monitoring of balance test substances and the test weights required for this. In KERN's accredited DKD calibration laboratory test weights and balances may be calibrated (return to the national standard) fast and at moderate cost.

4 Basic Safety Precautions

4.1 Pay attention to the instructions in the Operation Manual



- ⇒ Carefully read this operation manual before setup and commissioning, even if you are already familiar with KERN balances.
- ⇒ All language versions contain a non-binding translation. The original German is binding.

4.2 Symbols used in the operating instructions

	Please pay due attention to information denoted by the signal words CAUTION or WARNING as well as a warning pictogram.
WARNUNG! WARNUNG!	The signal word WARNING indicates a hazardous situation where disregard of the safety information may result in fatal or severe injury.
VORSICHT! CAUTION!	The signal word CAUTION indicates a hazardous situation where disregard may result in minor injury.
 	NOTE (or LOOK OUT) indicates actions that may result in damage to property.
	This symbol indicates helpful information.
⇒	Call to action. This prompts you to perform certain operations

4.2.1 Warning pictograms



High voltage



Chemical burn / corrosion



General hazard



Fire or explosion



Poisoning



Hot Surface

4.3 Personnel training

The instrument may only be operated and maintained by trained personnel.

4.4 Danger Information



WARNING!

- ⚠ The moisture analyser is used to analyse the moisture content of materials. This instrument must be used exclusively for this purpose. Any other usage may cause a risk to personnel, damage to the instrument or other material damage.
- ⚠ The moisture analyser should be used mainly for the drying of aqueous substances.
- ⚠ The moisture analyser may not be used in a hazardous area.
- ⚠ Do not use the moisture analyser in an explosive environment.
- ⚠ The operation and maintenance of the moisture analyser is restricted to trained competent specialist staff.
- ⚠ Carefully read this operation manual before setup and commissioning, even if you are already familiar with KERN instruments.
- ⚠ Never make any modifications or design changes to the equipment whatsoever. Always use original spare parts and accessories.
- ⚠ Make sure that liquids cannot penetrate the interior of the device, the terminals at the rear of the device and the connected peripherals (such as printer, PC). If you spill liquid on the device, disconnect it immediately. Afterwards do not operate the moisture meter and have it checked by a competent KERN stockist before any further use.



Hazards during and after measuring

- ⚠ Ensure correct installation of all components, see chap. 6.3
- ⚠ Careful when removing the sample. The sample itself, the sample dish and the heating unit may be very hot.
- ⚠ Use the sample retainer at all times as it allows safe working and prevents burns.
- ⚠ Individual parts of the case (e. g. the ventilation grids) may heat up considerably during operation.



CAUTION!**The moisture analyser operates using heat!**

- ☞ Maintain sufficient space in the environment of the instrument to prevent heat build-up (distance from the instrument 20cm, upwards 1m).
 - ☞ The heat extractor of the sample must never be covered, blocked, taped up or altered in any other way.
 - ☞ Never place combustible materials on, under or next to the instrument, as the environment of the instrument heats up to a high temperature.
 - ☞ Careful when removing the sample. The sample itself, the sample dish and the heating unit may be very hot.
-



CAUTION!**Fire or explosion**

- ☞ Explosive, easily flammable samples and samples that go into a chemical reaction when subjected to heat, may not be analysed with the moisture analyser.
 - ☞ If in doubt, conduct a risk analysis.
 - ☞ Select a drying temperature for samples of this kind that is low enough to prevent ignition or explosion.
 - ☞ Wear safety goggles.
-



WARNING!**Substances that contain toxic or corrosive ingredients, produce toxic gases when drying, cause irritation (eyes, skin, airways), induce nausea or result in death**

- ☞ Sample materials emitting toxic substances must be dried with a special extraction system in place. Create an environment that prevents the inhalation of vapours hazardous to health.
-



WARNING!**Substances that liberate corrosive gases when heated up (such as acids)**

- ☞ In that case, work with smaller sample amounts as the liberated gases may condense on cooler casing parts and later cause corrosion.
-

5 Transport and storage

5.1 Testing upon acceptance

When receiving the appliance, please check packaging immediately, and the appliance itself when unpacking for possible visible damage.

5.2 Packaging / return transport



- ⇒ Keep all parts of the original packaging for a possibly required return.
- ⇒ Only use original packaging for returning.
- ⇒ Prior to dispatch disconnect all cables and remove loose/mobile parts.
- ⇒ Secure all parts against shifting and damage.

6 Unpacking, Setup and Commissioning

6.1 Installation Site, Location of Use

The instrument is designed to achieve reliable weighing results under normal conditions of use.

You will work accurately and fast, if you select the right location for your moisture analyser.

On the installation site observe the following:

	Remove explosion prone and easily flammable material in the immediate vicinity. Emerging vapours, sample dish and all parts of the sample chamber are hot!
	Protect the instrument against direct draughts due to open windows and doors.
	Avoid extreme heat and temperature fluctuations e.g. due to installation next to radiators.
	Do not expose the instrument to extreme dampness for longer periods of time. Non-permitted condensation (condensation of air humidity on the instrument) may occur if a cold instrument is taken to a considerably warmer environment. In this case, acclimatize the disconnected instrument for ca. 2 hours at room temperature.
	Avoid direct sunlight
	The air humidity should be between 45% and 75%, non-condensing.

⚠	Sufficient distance from heat-sensitive materials in area around instrument.
⚠	Protect the instrument against high humidity, vapours and dust,
⚠	Major display deviations (incorrect weighing results) may be experienced should electromagnetic fields (e.g. due to mobile phones or radio instruments), static electricity accumulations or instable power supply occur. Change location or remove source of interference.
⚠	Avoid static charging of the material to be weighed, weighing container and windshield
⚠	Place the instrument on a firm, level surface.
⚠	Avoid jarring during weighing.

6.2 Unpacking and checking

Take the moisture analyser carefully out of its packaging, remove the plastic jacket and install it at the designated work space.

6.2.1 Scope of delivery / serial accessories:

- Moisture analyser, see illustration chap. 2
- 50 sample dishes
- Power cable
- Operating manual

6.3 Placing

The moisture analyser is supplied part-assembled. Control whether the delivery is complete immediately after unpacking the individual parts and assemble the separate component parts according to the sequences.

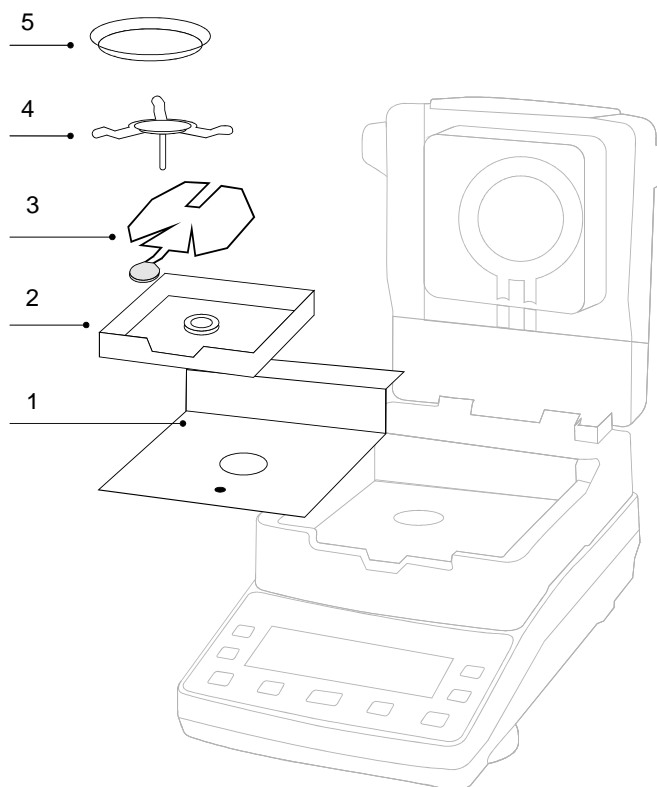

1. Put heat shield into the sample chamber.
2. Place windshield in a way that the pin in the heat shield is aligned to the hole in the heat shield.

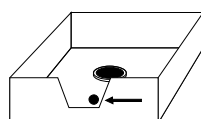

3. Place removal aid into the windshield. Ensure that the lug lies exactly in the groove of the windshield.
4. Attach the sample dish holder carefully and rotate it until it locks.
5. Put the sample dish on the removal aid.

6.4 Levelling

Precise alignment and stable installation are a precondition for repeatable results. To compensate for minor unevenness or tilts of the base, level the instrument.

- ⇒ Level instrument with foot screws until the air bubble of the water balance is in the prescribed circle.

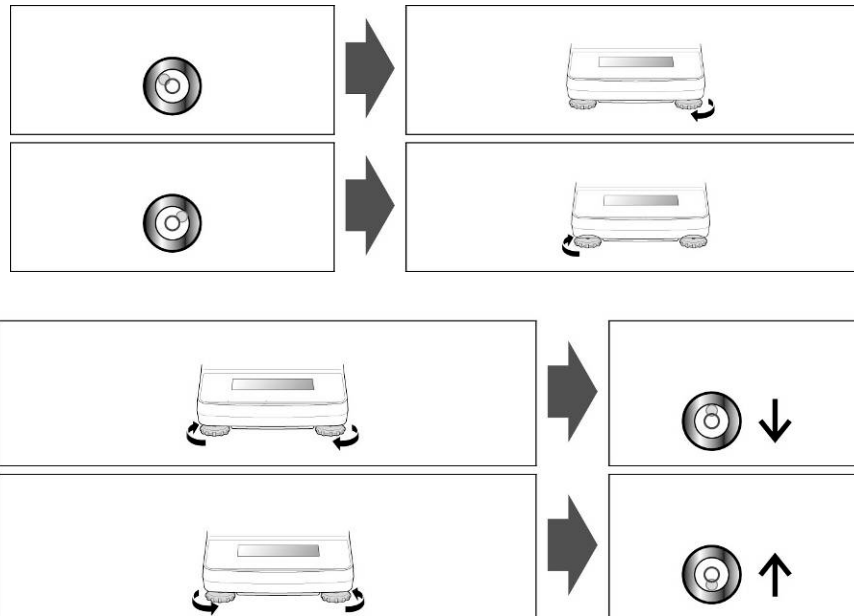

- ⇒ Check levelling regularly

6.5 Mains connection



Power supply is provided via the supplied mains cable.

Check, whether the voltage acceptance on the device is set correctly. Do not connect the appliance to the power grid unless the information on the instrument (sticker) matches the local mains voltage.

Do not eliminate the protective effect by using an extension lead without earth terminal. For power supplies from power grids without earth terminals call a specialist to establish equivalent protection according to the relevant installation regulations.

- The mains plug must be accessible at any time.
- Prior to commissioning check the mains cable for damage.
- Place the cable in a way that it cannot be damaged or handicaps the measuring process.



Important:

Does the rating match the standard local mains current?

- Do not connect if mains voltages are different!
- If matching, connect the moisture analyser.

6.6 Switching on and off



Turn on appliance by pressing the **ON/OFF** key.

The display lights up and the equipment conducts a self-test. Wait until basic configuration appears.



To **switch off** press the ON/OFF button, the display disappears.

6.6.1 Initial Commissioning

In order to receive precise weighing results from electronic balances, the instrument unit must have reached its operating temperature (see warming-up time chapter 1). For this warm-up period the integrated balance must be connected to the power supply.

The accuracy of the integrated balance depends on the local acceleration of gravity. Please observe hints in chapter Adjustment.

6.7 Connection of peripheral devices

Before connecting or disconnecting of additional devices (printer, PC) to the data interface, always disconnect the moisture analyser from the power supply.

Only use accessories and peripheral devices by KERN, as they are ideally tuned to the appliance.

7 Adjustment

7.1 Weight adjustment

The weight adjustment of the integrated balance is not absolutely necessary for a correct moisture determination, as this measurement is only carried out relatively. The instrument calculates the weight of the sample before and after the drying process and the moisture content is determined with help of the ratio between wet weight and dry weight.

The instrument however should be adjusted, if this is required due to the quality system used by you.

Procedure:

- i** • Observe stable environmental conditions. A warming up time (see chapter 1) is required for stabilization.
- Carry out adjustment with placed sample dish. Ensure that no objects are within the sample dish.
- Carry out adjustment as near as possible to the balance's maximum weight (recommended adjustment weight see chap. 1). Info about test weights can be found on the Internet at: <http://www.kern-sohn.com>.

⇒ Press and keep  pressed until „CAL“ is displayed.



⇒ Wait until the weighed value for the required adjustment weight appears flashing.



- ⇒ Put the required adjustment weight carefully into the centre of the sample dish and close heating hood. Adjustment is carried out automatically.

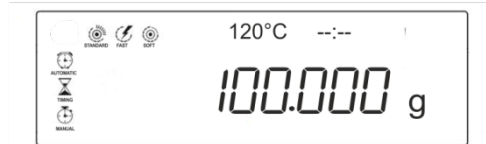
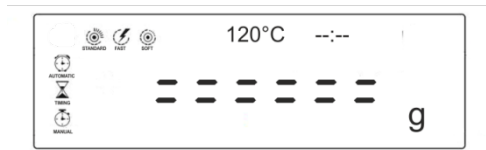

- ⇒ After successful adjustment the balance automatically returns to weighing mode, „100,000 g“ will be displayed. Take away adjustment weight.

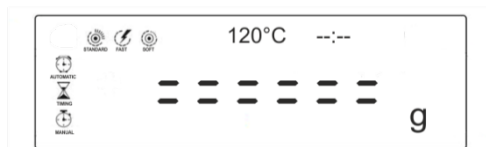

- ⇒ Wait until „0.000 g“ appears.



7.2 Calibrate / adjust temperature of the heating module

7.2.1 Temperature calibration

We recommend performing occasional tests of the instrument's temperature value, using the optional temperature calibration set **KERN DAB-A01**.



Before you do this, allow the device to cool down for at least 3 hours after the last heating phase.

Preparation:

- ⇒ Switch off moisture analyser
- ⇒ Install temperature calibration set as per illustration
- ⇒ Turn on moisture analyser



Set test parameters:

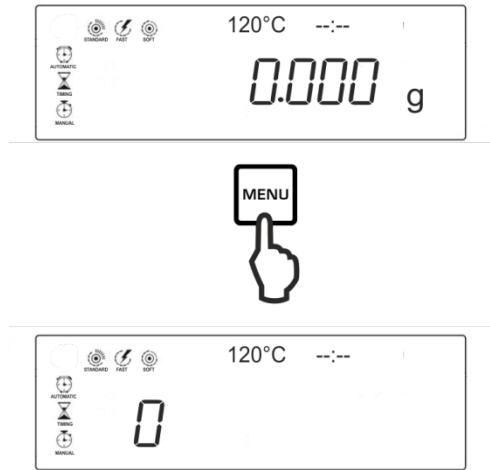

- ⇒ After pressing **MENU** the first ident number <0> will be displayed.
- ⇒ Using arrow keys **↓** **↑** select e.g. ident number <1> and confirm by **ENTER**. The currently set heating profile flashes.

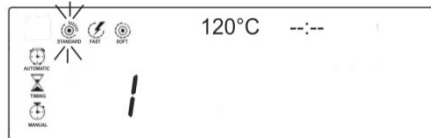

- ⇒ Using arrow keys **↓** **↑** select heating profile <SOFT> and confirm by **ENTER**.

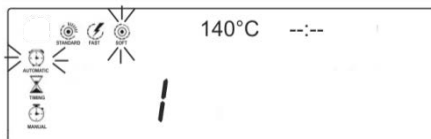

The currently set heating profile and switch-off criterion flashes.

- ⇒ Use the arrow keys **↓** **↑** to select switch-off criterion <MANUAL>.

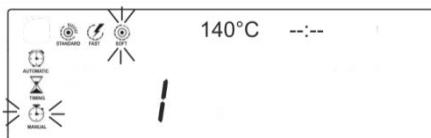

⇒ Confirm by , the currently set drying temperature flashes.

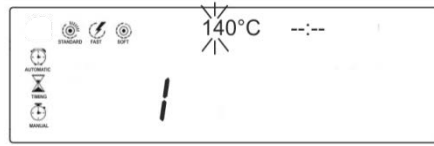

⇒ Use the arrow keys to enter the desired test temperature. For the first or the first two digits select a value and confirm by .

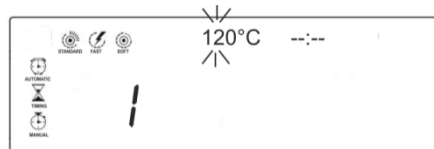

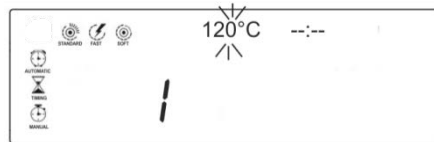

⇒ Using arrow keys select the desired value for the last digit.



⇒ Confirm input by .



Begin temperature calibration:

- ⇒ Switch on temperature calibration set.
- ⇒ Close heating hood and press . The instrument will be automatically heated to the set temperature. The current temperature and the elapsed time will be indicated in the display.
- ⇒ After approx. 15 minutes finish by . Compare the temperature value of the moisture analyser with that of the temperature calibration set. At a difference of $\pm 5^{\circ}\text{C}$ we recommend to adjust the temperature, see following chapter.

7.2.2 Temperature adjustment



If the admissible deviation is exceeded / not reached during temperature calibration the temperature of the instrument can be adjusted as described below.

1. Switch off instrument.

2. Press , quickly release, then press  and  at the same time.



„8.2X“ will be displayed. If not, separate device from power supply and restart step two.

3. Adjust temperature using arrow keys  . Each time you press the button the temperature will be increased or reduced by 1°C .
4. Confirm input by .

8 Carry out your first measurement

We recommend to carry out a first simple measurement in order to get acquainted with the device and the displays. Here you work with the ex-factory set drying parameters (standard drying 120°C, automatic switch off).

i In order to obtain exact results, the instrument must have reached its operating temperature (see warm-up time chap. 1). For this warm-up time the instrument must be connected to the power supply.

- ⇒ Place into the sample dish a dry piece of paper
- ⇒ Place removal aid with the sample dish on the sample dish retainer. Make sure that the sample dish is resting flat on the sample dish retainer. Always work with a removal aid as this will enable safe working and prevent burns.
- ⇒ Close heating hood and tare with .



- ⇒ Open heating hood.
Pour approx. 3 g of water on the paper in the sample dish.



Wait until the stability monitor „o“ goes out.

- ⇒ Close heating hood.
- ⇒ Start the drying process by .



The status display  indicates the enabled drying process

You can watch the drying process on the display screen.

The current temperature, lapsed time as well as the current interim result will be continuously updated and displayed.

The icons of the enabled heating profile and the switch-off criterion are flashing.

Using  the display can be switched over to the different displays of results.

- ⇒ When drying is finished, an acoustic signal will sound. The result will be displayed.

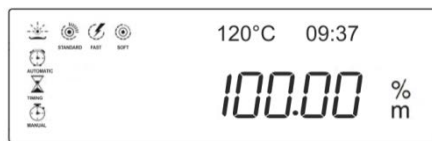

- ⇒ Using  the display of results can be switched over into % moisture ➔ % dry content ➔ residual weight in grams.

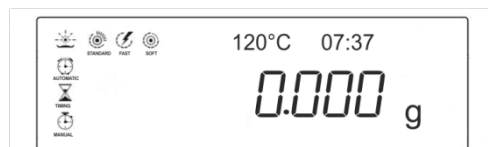

- ⇒ Open the heating hood and remove the sample with the help of the removal aid. **Caution:** Sample dish and all parts of the sample chamber are hot!
- ⇒ Using  the result in the display will be deleted. The display returns to weighing mode. The device is now ready for another measurement.

9 Define drying parameters

In chapter 8 you have already carried out a first measurement with the factory settings.

The device provides a great variety of setting options that allow you to adapt a drying method to your sample.

Three heating profiles (standard drying, soft drying, fast drying) and three switch-off criteria (time-controlled, automatic, manual) can be selected.

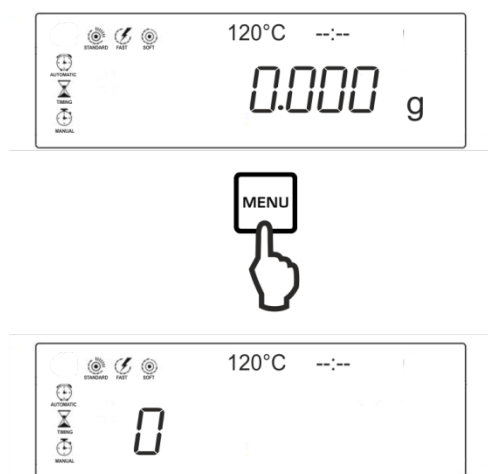

1. Enter ident number for drying method

16 memory locations, which can be simply called up and started as necessary under the saved ident number (0 –F), are available for complete drying methods.

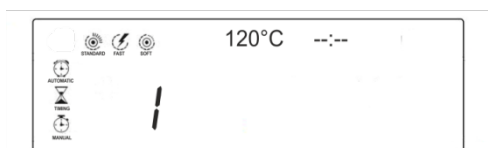

- ⇒ After pressing  the first ident number <0> will be displayed. This memory location is provided for the factory settings (standard drying 120°C, automatic switch-off) and cannot be changed.



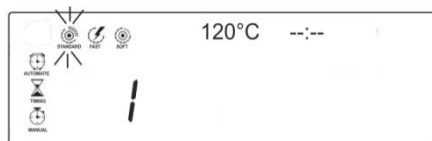

- ⇒ Use the arrow keys   to select the desired ident number and confirm by . The currently set heating profile flashes.

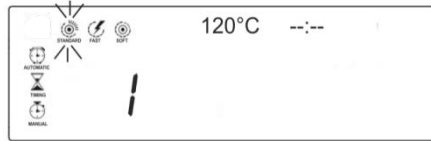

2. Set heating profile



⇒ Using arrow keys   select required heating profile and confirm by .

Options:



Standard drying



Fast drying



Soft drying



Standard drying <STANDARD>

This heating profile is suitable for most samples. The sample will be heated up to the set drying temperature and will be kept constantly at this temperature. Selectable 40°C -199°C

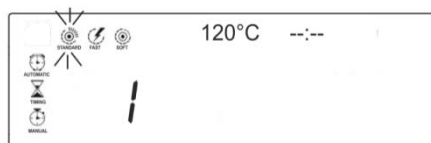
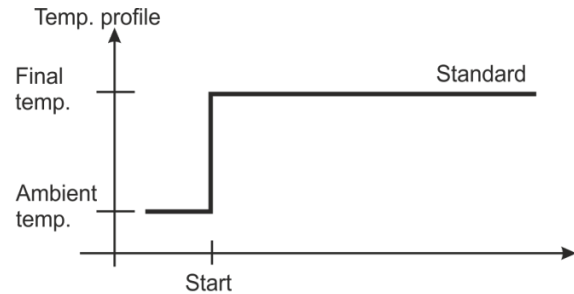



Fast drying <FAST>

This heating profile is suitable for samples with high moisture content (such as liquids).

The temperature will initially rise very fast after the start and for a short time will exceed the set drying temperature by 30%. That way the latent heat will be compensated, thereby accelerating the drying process.

Then the temperature is controlled down to the set value.

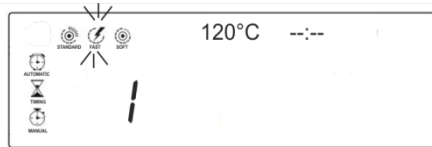
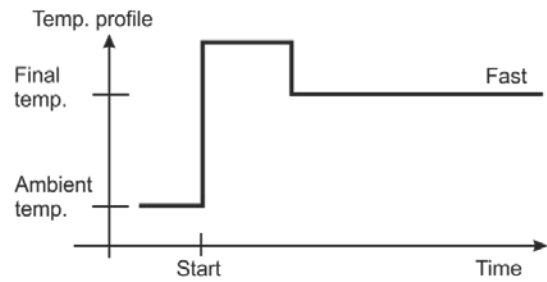

Soft drying <SOFT>

This heating profile is suitable for soft drying of substances prone to skin formation (such as easily liquefiable substances or substances containing sugar). Skin formation affects the evaporation of trapped moisture. The temperature will be increased continuously and will not reach the set drying temperature before the so-called ramp duration has elapsed.

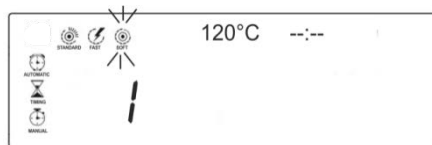
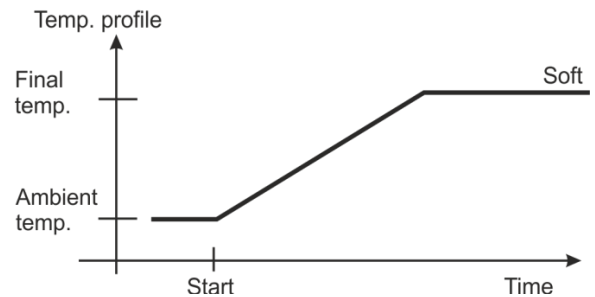



3. Selecting switch-off criterion

A switch-off criterion defines under which conditions the device should cancel the drying process. Switch-off criteria save continuous time controls and manual cancelling of drying processes. Furthermore they ensure that measurements are always finished under the same conditions, thereby providing repeatable measurements.

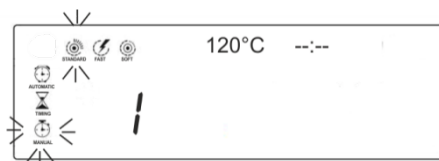
- ⇒ After acknowledgement of the selected heating profile by , the currently set heating profile and switch-off criterion flashes.



- ⇒ Using arrow keys   select required switch-off criterion and confirm by .

Selectable settings suitable as switch-off criteria include:

<AUTO>

Automatic switch off
(2mg weight loss in 45 s)



This switch-off criterion is based on a weight loss per time unit. As soon as the medium weight loss drops below the desired value per unit of time, the measurement will be finished automatically.

<TIMING>

Time-controlled switch off,
selectable 3 min – 99h 59 min
(10s steps)



When this switch-off criterion is selected the measurement will continue until the set drying time has lapsed (max. time 99h 59 min).

<MANUAL>





Manual switch-off by pressing stop key

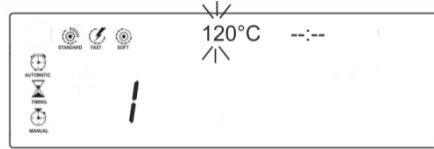

4. Set drying temperature

⇒ After acknowledgement of the selected switch-off criterion by , the currently set drying temperature is flashing.

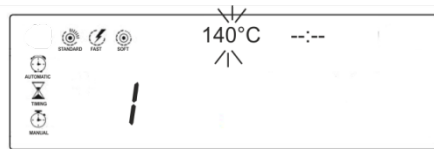

⇒ Using arrow keys  , select the desired value for the first or the first two digits and confirm by .



⇒ Using arrow keys   select the desired value for the last digit.

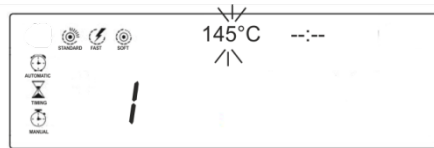

⇒ Confirm input by .

If as switch-off criterion **<AUTO>** or **<MANUAL>** is selected, the parameter setting is finished here. All parameter settings will be applied to a subsequent drying process and displayed on screen. All settings are stored under the ident number <1> until a new method is allocated to the ident number.

<AUTO>



<MANUAL>



When **<TIMING>** is selected, the display of setting the drying period of time is flashing, see step „5“.

5. Setting the drying period for time-controlled switching-off

- ⇒ After acknowledgement of the drying temperature by **ENTER**, the currently set drying period is flashing.

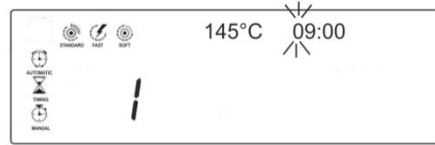

- ⇒ Using arrow keys **↓** **↑**, select the desired value for the first digit and confirm by **ENTER**, the next digit is flashing.

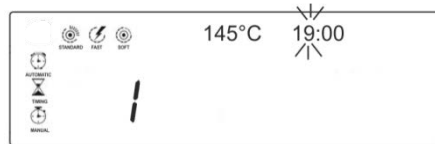

- ⇒ Using arrow keys **↓** **↑**, select the desired value for the next digit and confirm by **ENTER**, the next digit is flashing. Repeat this procedure for all digits.

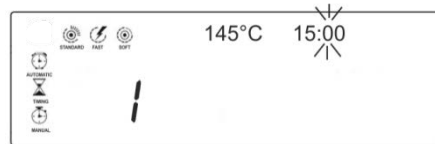



- ⇒ Confirm input by **ENTER**. All parameter settings will be applied to a subsequent drying process and displayed on screen. All settings are stored under the ident number <1> until a new method is allocated to the ident number.



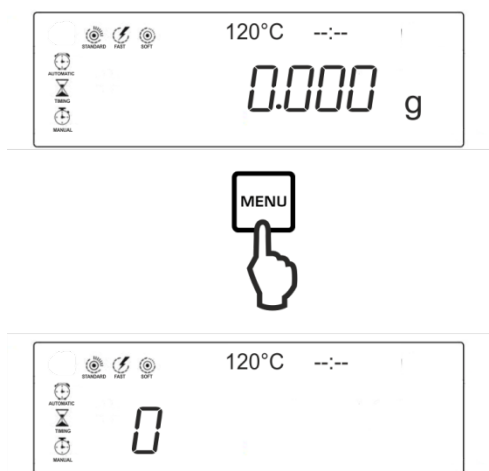

10 Carrying out drying and measuring processes

- i** ➤ In order to obtain exact results, the instrument must have reached its operating temperature (see warm-up time chap. 1). For this warm-up time the instrument must be connected to the power supply.
- Either invoke a drying method stored beforehand or set drying parameters as specified in chapter 9.



- ⇒ After pressing the button  the first ident number <0> of a drying method will be displayed.

- ⇒ Use arrow keys   to select a desired ident number of a drying method and confirm by . The currently set heating profile flashes.

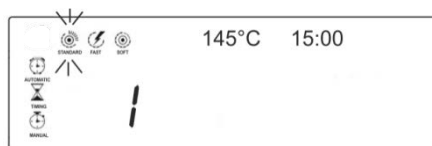

- ⇒ Confirm all flashing indicated parameters one by one by **ENTER** or change them as necessary.



- ⇒ Open heating hood and place removal aid with an empty sample dish on the sample dish retainer. Make sure that the sample dish is resting flat on the sample dish retainer. Always work with a removal aid as this will enable safe working and prevent burns.

- ⇒ Close heating hood and tare with **TARE**.
- ⇒ Open heating hood.
Distribute sample evenly on the sample tray. A practical sample amount is typically approx. 3- 5 g.



- ⇒ Close heating hood.
- ⇒ Start drying process by **START STOP**.



The status display  indicates the enabled drying process

You can watch the drying process on the display screen.

The current temperature, lapsed time as well as the current interim result will be continuously updated and displayed.

The icons of the enabled heating profile and the switch-off criterion are flashing.

- i** Using  the display can be switched over to the different displays of results.

- ⇒ When drying is finished, an acoustic signal will sound. The result will be displayed.



- ⇒ Using  the display of results can be switched over into % moisture ➔ % dry content ➔ residual weight in grams.

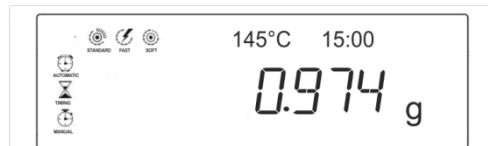

- ⇒ Open the heating hood and remove the sample with the help of the removal aid. **Caution:** Sample dish and all parts of the sample chamber are hot!
- ⇒ Using  the result in the display will be deleted. The display returns to weighing mode. The device is now ready for another measurement.

11 RS 232 interface

Condition:

The following conditions must be met to provide successful communication between the moisture analyser and the printer.

Disconnect moisture analyser from the power supply and connect to the appliance interface with a suitable cable. Faultless operation requires an adequate KERN interface cable.

Communication parameters of the RS 232 interface of moisture analyser and printer must match.

11.1 Technical data

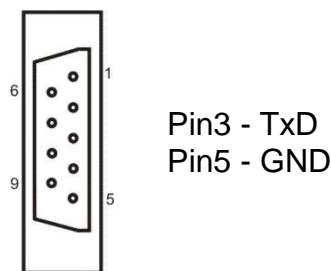

Connection 9 pin d-subminiature bushing



Baud-Rate 1200 / 2400 / 4800 /9600 selectable

Parity 7bits / 2 stop bits

11.2 Setting the baud rate

⇒ Press , then release quick und press  fast. The current baud rate is indicated.

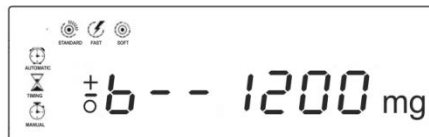

⇒ Using arrow keys   select baud rate .





⇒ Confirm with .





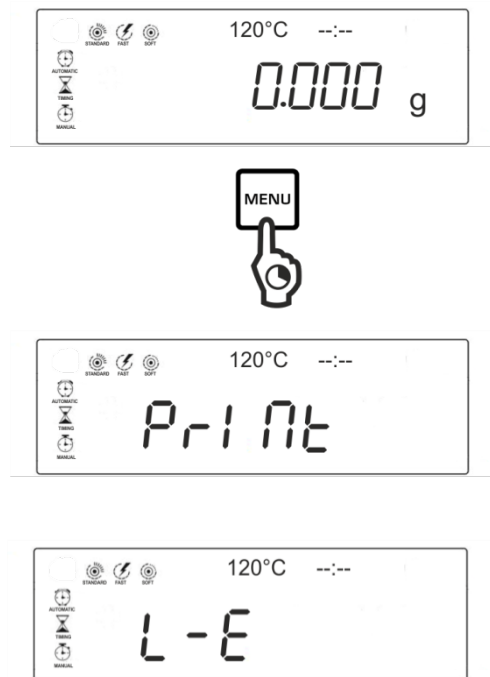

11.3 Print out protocol:

- ⇒ To edit a protocol press  and keep it pressed until "PRINT" appears. The display changes automatically to „L-C“.

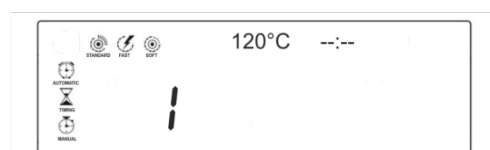

- ⇒ Acknowledge with . The protocol of the measurement carried out as last is displayed under the ident number „1“. The instrument stores the last five protocols (ident number 1 -5). With every new measurement, the ident number One will be overwritten.



- ⇒ Use the arrow keys   to select the desired ident number and confirm by . The protocol will be edited.

Sample protocol (KERN YKB-01N):

MOISTURE DETERMINATION (1)		<i>Protocol ident number (1)</i>
Machine Type:	DAB 100-3	<i>Gerätetyp</i>
Heating Mode:	STANDARD	<i>Selected heating profile</i>
Stop Mode:	AUTO STOP	<i>Selected switch-off criterion</i>
Heating Temp:	120 °C	<i>Drying temperature</i>
Time elapsed:	03:52	<i>Overall duration of drying process</i>
Wet W:	10.145 g	<i>Start weight</i>
Dry W:	10.010 g	<i>Residual weight</i>
Moisture:	1.32 %M	<i>Final result in % moisture</i>

12 General information concerning moisture analysis

12.1 Application

In all cases where moisture is added to or removed from products, a fast determination of the moisture content is of enormous importance. For countless products the moisture content is not only a quality feature but also an important cost factor. Very often fixed limits for moisture content apply to the trade in industrial or agricultural goods as well as chemical or food products which are defined by terms of delivery and general standards.

12.2 Basics

Moisture does not only mean water but includes all substances that evaporate when heated up. In addition to water this includes,

- Fats
- Oils
- Alcohol
- Solvents
- etc...

There are various methods to analyse moisture in a product.

KERN DAB uses a method called thermogravimetrics. In accord with this method, the sample is weighed before and after heating, determining the material moisture by looking at the difference.

The conventional drying chamber method follows the same principle, with the exception that this method requires a considerably longer measuring period. . In accord with the drying chamber method, the sample is heated from the outside to the inside by a hot air current, so as to remove the moisture. The radiation applied in the KERN DAB penetrates mainly the sample in order to be transformed inside it into heat energy that is, warming from the inside to the outside. A minor amount of radiation is reflected by the sample, a reflection that is less in dark samples than in light-coloured ones. The depth of penetration of the radiation depends on the permeability of the sample. In samples of low permeability the radiation only penetrates the outer layers of the sample, possibly resulting in imperfect drying, incrustation or burning. For that reason the preparation of a sample is of great importance.

12.3 Adjustment to existing measuring method

KERN DAB frequently replaces a different drying method (such as drying cabinet) as easier operation achieves shorter measuring periods. For that reason the conventional measuring method must be matched to the KERN DAB in order to achieve comparable results.

- Performing parallel measurements
 - Lower temperature setting for KERN DAB than for drying cabinet method
- Result of KERN DAB does not match reference
 - Repeat measurement with changed temperature setting
 - Vary shutoff criterion

12.4 Preparing a sample

Prepare one sample at a time for measuring. This prevents the sample from exchanging moisture with its surroundings. If several samples have to be taken at the same time, they should be packed in airtight boxes so that they do not undergo changes during storage.

To receive reproducible results, spread the sample thinly and evenly on a sample dish.

Patchy spreads will produce inhomogeneous heat distribution in the sample to be dried resulting in incomplete drying and increased measuring time. Sample clusters generate increased heating of the upper layers resulting in combustion or incrustation. The high layer thickness or possibly arising incrustation makes it impossible for the moisture to escape from the sample. Due to this residual moisture, measured results calculated in this way will not be comprehensible or reproducible.

Preparing a sample from solids:



- Spread powdery or grainy samples evenly on the sample dish.
- Grind coarse samples using a mortar or a shredder. When grinding the sample avoid any heat supply as this may cause loss of moisture.

Preparing a sample from liquids:



For liquids, pastes or melting samples we recommend to use a glass fiber filter. The glass fiber filter has the following advantages:

- even distribution thanks to capillary attraction
- no formation of droplets
- fast evaporation due to a greater surface

12.5 Sample material

Easy to determine are usually samples with the following characteristics:

- Grainy to powdery, pourable solids
- Thermally stable materials, emitting the moisture to be determined easily without other substances evaporating at the same time
- Liquids that vaporize to leave a dry substance without developing a film

Difficult to determine may be samples that are:

- Glutinous or sticky
- Become incrustrated easily or tend to form a film
- Decompose easily under the influence of heat or emit various elements

12.6 Sample size / originally weighted in quantity

Drying times, as well as achievable accuracy, are significantly influenced by sample distribution. In the course of this arise two opposed requirements:

The lighter the originally weighted in quantity, the easier it is to achieve shorter drying times. However, the heavier the originally weighted in quantity, the more accurate a result.

12.7 Drying temperature

The temperature has to be selected in a manner that the sample is not decomposed or changes its chemical structure. But on the other hand if the temperature is too low, drying time may be unnecessarily extended.

Bear in mind the following factors when setting the drying temperature:

Surface of the sample:

Compared with powdery or grainy samples, liquid and spreadable samples have a smaller surface for the transmission of heat energy.

The use of a glass fibre filter improves the heat application.

Colour of sample:

Light-coloured samples reflect more heat radiation than dark ones and therefore require a higher drying temperature.

Availability of volatile substances:

The better and faster the water or other volatile substances can be disposed, the lower a drying temperature is required. If water is difficult to get to (e. g. in synthetics), it has to be calcined at high temperatures (the higher the temperature, the higher the water vapour pressure).

Results equivalent to other moisture analysing methods (e. g. drying chamber) can be achieved by experimentally optimising the setting parameters such as temperature, heating level and shutoff criteria.

12.8 Recommendations / Guidelines

Prepare standard sample:

- Crush sample, as required, and spread it evenly in the aluminium dish.

Prepare special samples:

- For sensitive or hard to spread test materials (e. g. mercury) a glass fibre filter is available for use.
- Spread sample evenly on glass fibre filter and cover it with a second glass fibre filter.
- The glass fibre filter is also useful as a protection when splashing materials are dealt with (each splash falsifies the final result).

You will find examples taken from actual use in our application manual, available from the KERN home page (www.kern-sohn.com).

13 Servicing, maintenance, disposal



Before any maintenance, cleaning and repair work disconnect the appliance from the operating voltage.

13.1 Cleaning



⇒ Only carry out cleaning tasks when the equipment has cooled down.

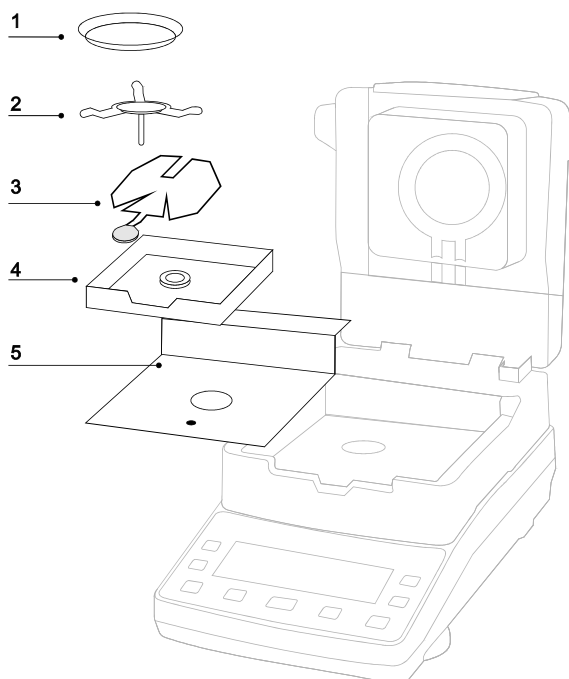

Open heating hood and remove all parts in the right order and clean. Please do not use aggressive cleaning agents (solvents or similar agents), but a cloth dampened with mild soap suds. Ensure that no liquid penetrates into the device. Polish with a dry soft cloth. Loose residue sample/powder can be removed carefully with a brush or manual vacuum cleaner.

13.2 Servicing, maintenance

- ⇒ The appliance may only be opened by trained service technicians who are authorized by KERN.
- ⇒ Ensure that the balance is regularly calibrated, see chap. Monitoring of test resources.

13.3 Disposal

- ⇒ Disposal of packaging and appliance must be carried out by operator according to valid national or regional law of the location where the appliance is used.

14 Instant help

Possible causes of errors:

In case of an error in the program process, briefly turn off the balance and disconnect from power supply. The weighing process must then restart from the beginning.

Fault	Possible cause
Display is not lit up.	<ul style="list-style-type: none">• The appliance is not switched on.• The mains supply connection has been interrupted (mains cable not plugged in/faulty).• Power supply interrupted.• Fuse has blown
The display does not change when a sample is being loaded	<ul style="list-style-type: none">• Sample dish / dish holder is fitted incorrectly.
The weight display changes constantly / the stability display does not appear.	<ul style="list-style-type: none">• Sample dish has contact with windshield or heating hood.• Draught/air movement• Table/floor vibrations• Electromagnetic fields / static charging (choose different location/switch off interfering device if possible)
Incorrect measuring result	<ul style="list-style-type: none">• Check adjustment• No resetting to zero before loading the sample
Measurement is taking too long	<ul style="list-style-type: none">• Incorrect shut-down criteria set
Measurement is not reproducible	<ul style="list-style-type: none">• Sample is not homogenous• Drying time is too short• Drying temperature too high (e.g. oxidation sample material, boiling point of sample exceeded)• Temperature sensor soiled or defective
Drying does not start	<ul style="list-style-type: none">• Heating hood open• The mains supply connection has been interrupted (mains cable not plugged in/faulty).

15 Declaration of conformity



KERN & Sohn GmbH

D-72322 Balingen-Frommern

Postbox 4052

E-Mail: info@kern-sohn.de

Phone: 0049-[0]7433- 9933-0

Fax: 0049-[0]7433-9933-149

Internet: www.kern-sohn.de

Declaration of conformity

EC Declaration of Conformity
EC- Déclaration de conformité
EC-Dichiarazione di conformità
EC- Declaração de conformidade
EC-Deklaracja zgodności

EC-Declaration of -Conformity
EC-Declaración de Conformidad
EC-Conformiteitverklaring
EC- Prohlášení o shode
ЕС-Заявление о соответствии

D	Konformitäts- erklärung	Wir erklären hiermit, dass das Produkt, auf das sich diese Erklärung bezieht, mit den nachstehenden Normen übereinstimmt.
EN	Declaration of conformity	We hereby declare that the product to which this declaration refers conforms to the following standards.
CZ	Prohlášení o shode	Tímto prohlašujeme, že výrobek, kterého se toto prohlášení týká, je v souladu s níže uvedenými normami.
E	Declaración de conformidad	Manifestamos en la presente que el producto al que se refiere esta declaración está de acuerdo con las normas siguientes
F	Déclaration de conformité	Nous déclarons avec cela responsabilité que le produit, auquel se rapporte la présente déclaration, est conforme aux normes citées ci-après.
I	Dichiarazione di conformità	Dichiariamo con ciò che il prodotto al quale la presente dichiarazione si riferisce è conforme alle norme di seguito citate.
NL	Conformiteit- verklaring	Wij verklaren hiermede dat het product, waarop deze verklaring betrekking heeft, met de hierna vermelde normen overeenstemt.
P	Declaração de conformidade	Declaramos por meio da presente que o produto no qual se refere esta declaração, corresponde às normas seguintes.
PL	Deklaracja zgodności	Niniejszym oświadczamy, że produkt, którego niniejsze oświadczenie dotyczy, jest zgodny z poniższymi normami.
RUS	Заявление о соответствии	Мы заявляем, что продукт, к которому относится данная декларация, соответствует перечисленным ниже нормам.

Electronic Balance: KERN DAB

EU Directive	Standards
2004/108/EC	EN 61000-6-3 : 2007+A1: 2011 EN 61000-3-2 : 2006+A1: 2009+A2 : 2009 EN 61000-3-3 : 2013 EN 61000-6-1: 2007
2006/95/EC	EN 61010-1 : 2010
2011/65/EU	EN 50581 :2012

Date 29.07.2015
Date

Ort der Ausstellung 72336 Balingen
Place of issue

Signatur
Signature

Albert Sauter
KERN & Sohn GmbH
Manager
Managing director

KERN & Sohn GmbH, Ziegelei 1, D-72336 Balingen, Tel. +49-[0]7433/9933-0
Fax +49-[0]7433/9933-149, E-Mail: info@kern-sohn.com, Internet: www.kern-sohn.com